



Pilous

Železná 9, 619 00 Brno, Czech Republic

Tel.: +420 543 25 20 10

e-mail: metal@pilous.cz, www.pilous.cz

Dynamic 3.0

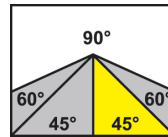

3150 x 27 x 0,9

	90°	+45°
●	300	240
■	285	220
■	300 x 220	235 x 150

Main motor	400 V, 50 Hz, 2,2 kW
Pump motor	400 V, 50 Hz, 0,12 kW
Hydraulic motor unit	400 V, 50 Hz, 0,55 kW
Feed rate of material	1,8 / 4,2 / 6,6 m/min.
Saw blade speed	15-90 m/min.
Working height of vice	870 mm
Hydraulic system oil	cca 26 l (ISO 6743/4-HM, DIN 51524 part 2-HLP)
Coolant tank	cca 35 l
Machine dimensions (min.)	1910 x 1910 x 1520 mm
Machine dimensons (max.)	2480 x 2300 x 1950 mm
Machine weight	940 kg

DESCRIPTION

Simpler, affordable, yet extremely powerful, accurate and robust. This fully automated band saw with CNC finds general application in series cutting. The machine features proportionally controlled hydraulic material feed. The machine can be controlled in fully automatic, semi-automatic or manual mode. In manual mode all functions of the machine are controlled separately. The maximum length of a single feed is 500 mm. Continuous manual adjustment of the cut angle in the range of 90-45 °. The saw can cut material at an angle even in automatic mode. The hydraulically controlled robust feeding vice moves on hard-chrome bars. The linear measuring system guarantees high measuring accuracy. High feed speed controlled by proportional equipment, CNC-controlled acceleration and deceleration process helps achieve a feeding accuracy of 0.1 mm. Smooth deceleration in the end positions also prevents slippage of heavy materials.

The central control panel with a large colour touch screen (7.5") guarantees very easy control of the machine using a proprietary operating system. You only enter the desired length and quantity. Material clamping and the movement of the band saw arm to the cut and back to the desired position according to the material cross-section are also controlled hydraulically. Pressure control of the feeding vice and the fixed vice as standard. Maximum cutting efficiency is maintained also thanks to the possibility of setting optimum saw band rate by a frequency converter in the range between 15 and 90 m/min., which significantly contributes to cutting accuracy and service life of saw bands.

The maximum material feed accuracy results from the robust design of the machine with all main parts made of grey iron and the sturdy design of the feeding system. The base design and the entire sturdy structure ensure an exceptional stability of the machine, even when cutting heavy workpieces. The base is equipped with a large removable chip container and allows the installation of a screw chip conveyor. The 27x0.9 mm industrial saw band is produced in many variants and enables industrial splitting of a wide range of materials, including stainless steel or tool steel. The latest concept of the arm casting with cavities is fitted with running wheels with an optimal diameter. The larger diameter of the wheels ensures less bending stress of the saw band. All this ensures an outstanding rigidity of the whole system, long service life of saw bands and maximum cut precision. All electrical wiring and the coolant delivery system are concealed in hollow parts of the arm, which means they are protected from damage. The new concept of the arm also brings a great simplification when changing the saw band or when cleaning the inside of the arm. You just need to open the hinged back cover of the arm and it will stay locked in the upper position.

Apart from creating an entirely new design of the arm, we also made many technical adjustments and changes improving the quality, user comfort and service life of the machine. As an accessory, it is possible to use the cleaning brush of the saw band that is synchronously driven by the driving wheel. Simple intuitive control using ergonomically positioned controls on a separate central control panel. The very robust machine framework composed of grey iron castings guarantees safe vibration absorption. The modern concept of the band saw arm allows large cutting ranges in perpendicular as well as angular cuts. Optimal-diameter running wheels and precise three-side hardened steel blade guides ensure long service life of the band and cutting accuracy. The optimal fit of the running wheels, the tensioning system and all rotating parts increases the service life of the machine. Noiseless and maintenance-free drive of the saw band is provided by an industrial electric motor with a worm gearbox. Check of the correct tension or tear of the saw band. When the saw band breaks, the machine automatically stops. The machine is connected to a complete cooling system with a powerful pump, enabling separate flow control on both guide heads and another adjustable outlet. The emulsion tank with a powerful pump is located in the machine base.

PHOTOGALLERY

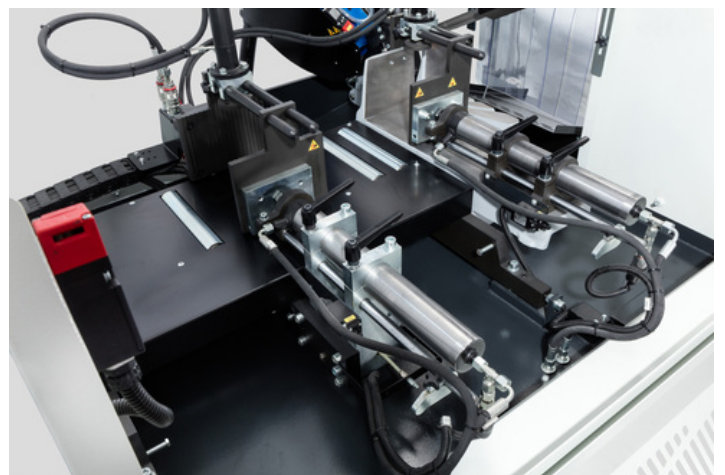
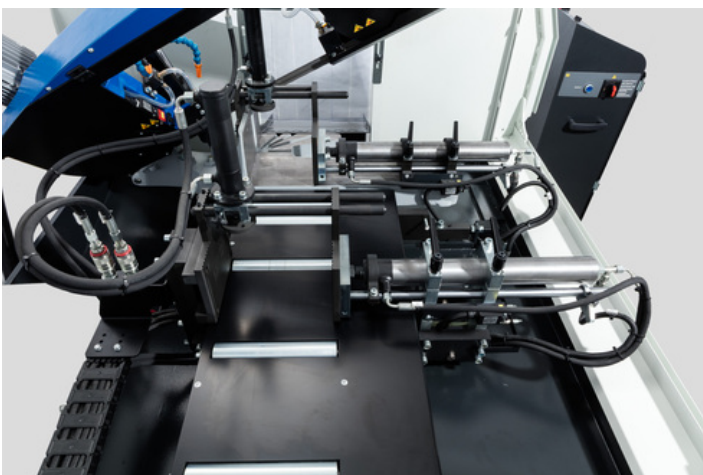

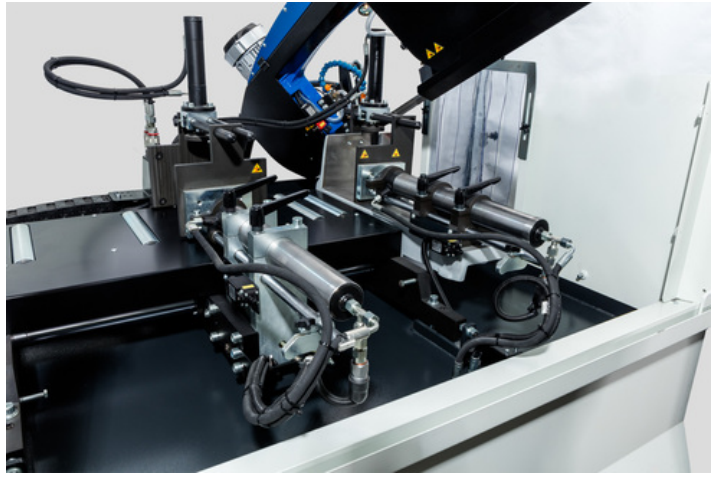
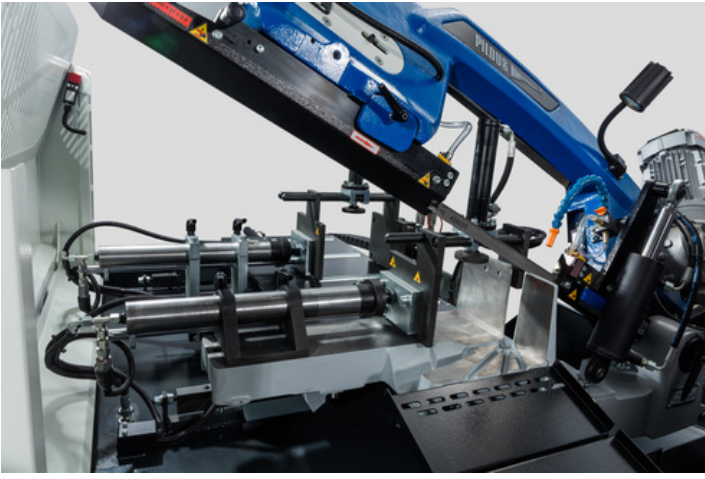



FR*

Frequency converter - Standard equipment

Enables continuous blade speed regulation between 15–90 m/min. and thus setting the optimum cutting conditions for the given material.



HVP NC 250/300/330

Hydraulic pressure device

Used to clamp bundles of material to be cut. It provides reliable clamping with hydraulically operated vertical pressure, working within the machine's cycle. It is installed on the fixed vice and feeding vice.

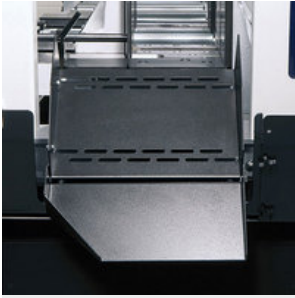

KL

Material chute

Continuously joins the vice behind the cut and allows for easy slide of cut pieces into a container when cutting larger series. The chute construction consisting of 2 parts prevents leakage of the coolant.



LA 50

Halogen lamp

Provides good lighting of the workplace of the machine. An invaluable tool especially when the lighting at the workplace is insufficient.



MM

Oil mist lubrication

Creates an oil mist that is sprayed onto the cutting edge. It replaces the use of a classic coolant, especially when cutting sections during which leakages may occur. Possibility of using organic oils.



LS

Laser alignment

High-quality industrial laser projects the cutting line on the material to be cut. Makes the setting of the required material length simpler, faster and more accurate.



KDM

Cleaning brush

Steel cleaning brush, driven by driving wheel. Used to remove chips from the saw band behind the cut.

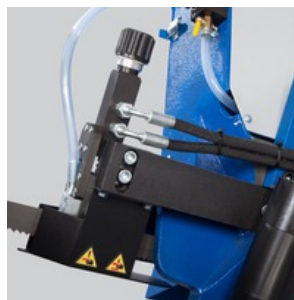

AG 330/380/400

Pressure regulation

Hydraulically controlled one-sided automatic regulation of saw band feed into cut according to the resistance of the material to be cut. Significantly reduces the cutting time and service life of the saw band.



SD

Screw chips conveyor

Ensures smooth removal of chips from the machine. Reduces the time needed for the cleaning of the machine especially when cutting series of full materials producing large amount of chips.



CD

Saw band tension indicator

Ensures accurate tensioning of the saw band to a required value according to the pressure gauge and its control during the use of the machine. Optimum tensioning of the saw band is essential for its service life and cutting accuracy.



OPL

Rinse spray gun

For cleaning working space of the machine.



SDB

Chip container

For easy handling is chip container equipped with wheels and swivel chip bin.

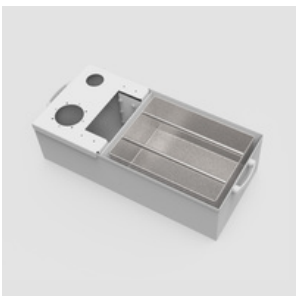

ST separator

Chip separator

The chip separator is a galvanized, finely perforated container for efficient collection of sawdust that has passed through a sieve in the base. This container is easily removable when filled and is easy to clean outside the machine.



STM magnetic separator

Magnetic chip separator

For particularly fine chips that have passed through the sieves in the saw, a highly efficient magnetic separator is used. It saves time for cleaning and disassembling the cooling path and extends the service life of the cooling emulsion. This device is easily removable and easy to clean outside the machine by simply pulling the magnetic bars out of the housing.

CONVEYORS

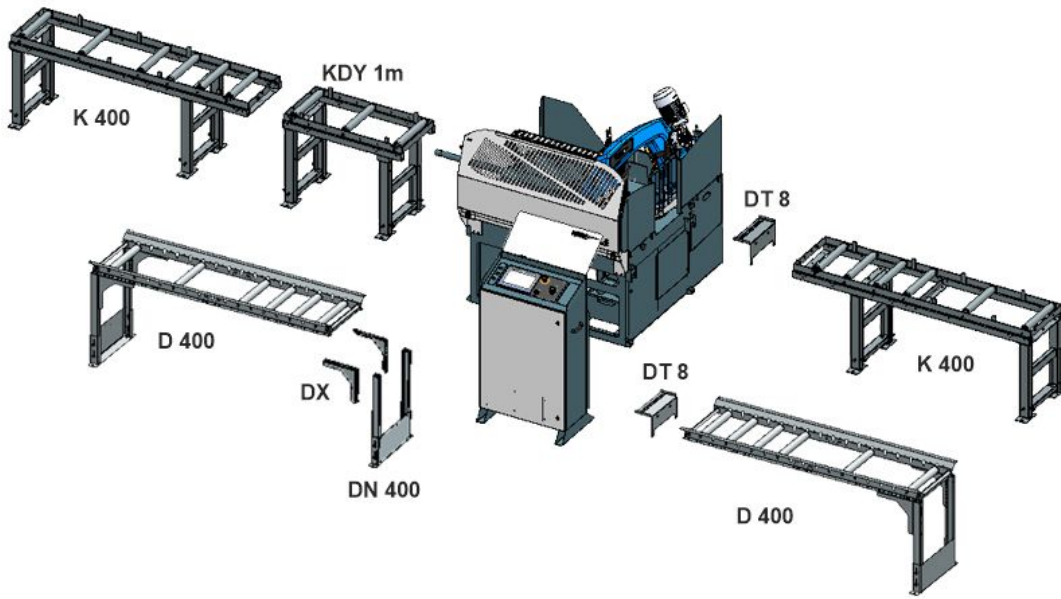



- Original bandsaw blades produced using the latest technology with top-quality German materials, while strictly complying with all stated production and control procedures.
- High productivity and precision of cut with the maximum service life of the blade is ensured.
- Wide range of produced types of sawblades and tooling enables the professional cutting of almost all available materials.

Bi-metal blade
Consists of bearing band from special steel on which a layer of HSS material is welded into where the teeth are milled.

Constant toothting
The distance of the teeth are always the same.

Variable toothting
The distance of teeth vary and is periodically repeated. This results in a greater cutting range, ability to further eliminate vibrations caused by the impact of the tooth blade on material, longer service life of the blade.

M42

Universal blade recommended for a wide palette of material, including tool steels and stainless steel up to hardness 45 HRC. Teeth are made from steel HSS-M42 containing cobalt.

M51

Blade for tool and stainless steel with hardness up to 50 HRC. Tooth tips are made from steel HSS-M42 containing cobalt and wolfram

Carbide

Consists of bearing band from special steel into which the teeth are milled on which especially grinded carbide plates are welded. The carbide mounted blade is recommended for cutting surface hardened materials, chrome parts, forged pieces and materials with external tenacity and hardness up to 62 HRC.

Cutting range

For optimal output of the blade, the correct selection of the size of the blade tooth is important depending on the size of the divided material.

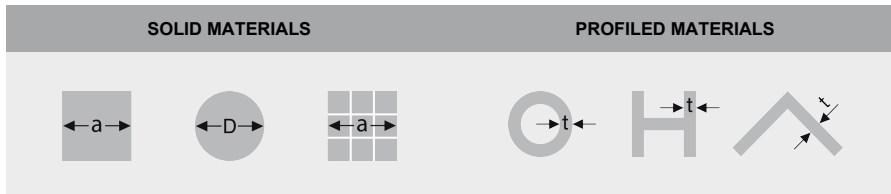

Variable toothting		Constant toothting		Variable toothting		Constant toothting	
a(D) [mm]		a(D) [mm]		t [mm]		t [mm]	
0-25	10/14	0-10	18	0-4	10/14	0-1	18
20-40	8/12 (8/11)	5-20	14	3-6	8/12 (8/11)	0-3	14
30-60	6/10	20-40	10	6-9	6/10	4-7	10
40-70	5/8 (5/7)	40-80	6	9-13	5/8 (5/7)	8-11	6
60-110	4/6	80-120	4	12-16	4/6	12-15	4
80-140	3/4	120-200	3	16-22	3/4	16-20	3
120-350	2/3	200-400	2	20-35	2/3	21-30	2
250-550	1,4-2	300-800	1,25	30-85	1,4-2	31-90	1,25
380-750	1/1,5			40-85	1/1,5		
550-3000	0,75/1,25			80-200	0,75-1,25		

When selecting the number of teeth for the blade, the general principle applies of a minimum of 4 teeth, but no more than 30 teeth are in contact with the work piece.

Be careful when unpacking welded saw blades. They are in a shipping container in tensioned condition. Remove the saw blade cover only after fitting it onto the machine.



COOLcut Standard

COOLcut Standard – universal coolant and lubricant.

Recommended concentration 5–10 %. 5 litres pack. Dilution 1:20.

- fluid allows achievement of optimal lubricating and cooling properties during the machining process
- low aromatic, highly refined paraffinic oil
- effective corrosion inhibitors provide permanent protection of the workpiece and the machine from corrosion
- bio stability and excellent wettability ensure excellent cooling and lubricating effect even in very hard water
- minimum tendency to foaming ensures effective lubrication
- high efficiency and profitability of use

Except use on log band saws the product is designed for machining operations carried out both on conventional machines and NC and CNC machining centres.



COOLcut Opti

COOLcut Opti – universal coolant and lubricant. Such machining fluid allows achievement of unique lubricating and cooling properties during the machining process.

Recommended concentration 4–7 %. 1 and 5 litres pack. Dilution 1:20.

- low aromatic, highly refined mineral oil
- effective corrosion inhibitors provide permanent protection of the workpiece and the machine from corrosion
- above average stability and excellent wettability ensure excellent cooling and lubricating effect even in very hard water
- minimum tendency to foaming ensures effective lubrication
- high efficiency and profitability of use
- long-term biostability

In addition to use in saw bands the product is designed for machining operations carried out both on conventional machines and NC and CNC machining centres.



COOLcut Eco 65

COOLcut Eco 65 – universal cooling and lubricating emulsifying oil, well biodegradable according to OECD 301-D test. Biodegradability of 65 % in 21 days.

Recommended concentration 4–7 %. 5 litres pack. Dilution 1:20.

- Such machining fluid allows achievement of unique lubricating and cooling properties during the machining process
- highly refined synthetic ester oil
- effective corrosion inhibitors provide permanent protection of the workpiece and the machine from corrosion
- above average stability and excellent wettability ensure excellent cooling and lubricating effect even in very hard water
- minimum tendency to foaming ensures effective lubrication
- high efficiency and profitability of use
- long-term biostability

In addition to use in saw bands the product is designed for machining operations carried out both on conventional machines and NC and CNC machining centres.



COOLcut Bio 90

COOLcut Bio 90 – universal cooling and lubricating emulsifying oil, well biodegradable according to OECD 301-D test. Biodegradability of 90 % in 21 days. Due to its biodegradability it can be used in any outdoor environment without environmental damage.

Recommended concentration 4–7 %. 5 litres pack. Dilution 1:20.

- Such machining fluid allows achievement of unique lubricating and cooling properties during the machining process
- highly refined synthetic ester oil
- effective corrosion inhibitors provide permanent protection of the workpiece and the machine from corrosion
- above average stability and excellent wettability ensure excellent cooling and lubricating effect even in very hard water
- minimum tendency to foaming ensures effective lubrication
- high efficiency and profitability of use
- long-term biostability

In addition to use in saw bands the product is designed for machining operations carried out both on conventional machines and NC and CNC machining centres.



COOLcut Micro

COOLcut Micro – an easily biodegradable semi-synthetic cooling and lubricating micro-emulsion. Due to its biodegradability it can be used in any outdoor environment without environmental damage. Such machining fluid allows achievement of unique lubricating and cooling properties during the machining process.

Pack of 5 litres. Use undiluted.

- highly refined synthetic ester oil
- effective corrosion inhibitors provide permanent protection of the workpiece and the machine from corrosion
- above average stability and excellent wettability ensure excellent cooling and lubricating effect even in very hard water
- minimum tendency to foaming ensures effective lubrication
- high efficiency and profitability of use
- long-term biostability

In addition to use in saw bands the product is designed for machining operations carried out both on conventional machines and NC and CNC machining centres. 5 litres pack.



COOLcut Antifreeze

COOLcut Antifreeze – low-freezing ingredient for water miscible coolants used in winter in outdoors environment, up to minus 20 °C, depending on the dosage.

5 litres pack. Dilution 1:20.

- effectively lowers the freezing point of the fluid
- very good resistance to oxidation guarantees long service life
- does not act aggressively on the sealing elements (elastomers), to which it comes into contact.

Optima Antifreeze	(%)	10	20	30	40	50
Flowability temperature	(°C)	-5	-10	-17	-26	-40

RECOMMEND



OH 90

Simple and very fast deburring of all kinds of sections (including the internal edges) or full material by a rotary steel brush. High quality construction of the machine along with a three-phase motor make use of the machine possible in specialized workshops as well as in production plants. Compared to manual deburring it reduces the required time and hence reduces your costs. While maintaining incomparably higher and balanced quality of deburring.

We recommend using stainless steel brush for stainless steel products.
Example of the difference between manual deburring (including internal edges) and OH 90

Hollow section 60 x 60 x 2 mm:	manual deburring - 32 s	machine OH 90 - 8 s
Tube diameter 50 x 2 mm:	manual deburring - 21 s	machine OH 90 - 4 s



OHE 90

Simple and very fast deburring of all kinds of sections (including the internal edges) or full material by a rotary steel brush. High quality construction of the machine along with a three-phase motor make use of the machine possible in specialized workshops as well as in production plants. Compared to manual deburring it reduces the required time and hence reduces your costs. While maintaining incomparably higher and balanced quality of deburring.

We recommend using stainless steel brush for stainless steel products.
Example of the difference between manual deburring (including internal edges) and OH 90

Hollow section 60 x 60 x 2 mm:	manual deburring - 32 s	machine OH 90 - 8 s
Tube diameter 50 x 2 mm:	manual deburring - 21 s	machine OH 90 - 4 s